

User Manual
ACTIVHUB[™] IR100

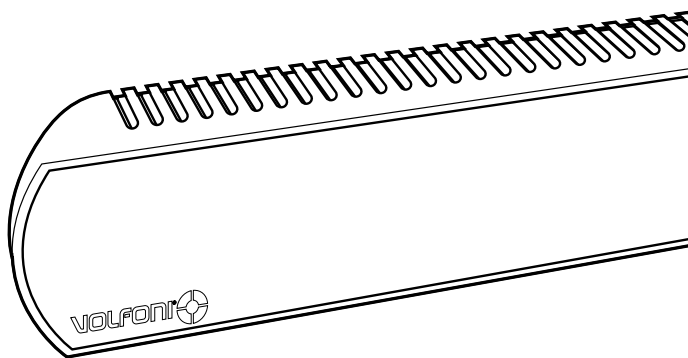

models **VPES-02000**

SUMMARY

Content	Page
1. OVERVIEW	4.
1.1 - GENERAL PRESENTATION	4.
1.2 - ACTIVHUB IR100 COMPOSITION	4.
2. PRODUCT DESCRIPTION	5.
2.1 - GLASSES	5.
2.2 - INFRA-RED EMITTER	6.
2.2.1 - EMITTER AT A GLANCE	6.
2.2.2 - BASIC SPECIFICATIONS	6.
2.2.3 - DIRECT INFRA-RED SPREAD OF THE EMITTER	6.
2.2.4 - CONFIGURATION ROOM	6.
3. ACTIVHUB IR100 FASTENING	7.
4. CONNECTION & SYNCHRONIZATION	8.
4.1 - SYSTEM CONNECTION	8.
4.2 - TECHNICAL SPECIFICATIONS	9.
5. WARRANTY	10.
6. CONTACTS	10.

1. PRODUCT PRESENTATION

1.1 - General presentation

As a result of Volfoni's long experience managing of the world's largest stock of 3D glasses, EDGE™ 1.2 exhibits the latest ergonomic and technical innovations. EDGE™'s comfort and easy of use is unmatched within the field of 3D glasses.

EDGE™ 1.2: High quality 3D glasses

- Unbeatable luminosity and natural colors
- Stylish ergonomic design, rugged and lightweight
- Exceptional comfort with universal nosepiece and 3 sizes of adaptable arms
- Automatic infrared synchronization, super wide receiving angle
- Very low maintenance with high durability coating and generic low cost battery

ActivHub IR100: All integrated 3D infra-red emitter

- Infra-red emitter working with quality and lightweight 3D glasses
- Cost saving solution for auditoriums up to 100 seats
- Easy and fast set-up with any 3D-Ready™ projectors
- No silver screen required, image quality preserved at all seating position

Accessories:

- Protective bag for distribution and storage
- Battery replacement tool
- Antibacterial cleaning wipes
- Adaptable "arms" to feet fit any head size

1.2 - ActivHub IR100 Composition

Thank you for using our ActivHub IR100. Before starting, please check if the following parts are included in the package.

A full ActivHub IR100 includes:

- EDGE™ 1.2 3D glasses
- Long range IR emitter
(infra-red emitter and synchronizer integrated)
- 4 cables :
 - 1 power cable 110/220V with US & EUR adapter - 3.1
 - 1 sync cable : GPIO SubD37 - 3.2
 - 1 sync cable : BNC - 3.3
 - 1 sync cable: SubD9 - 3.4
- 1 ceiling mountable with screws



1. EDGE™ 1.2 Glasses



2. IR / RF Emitter & Synchronizer +

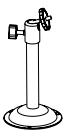

3. Security universal mount



4. Mounting screw and nylon fastener

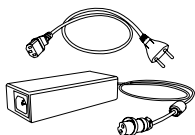

5. Power adapter



6. Din3-DB9 SYNC Cable

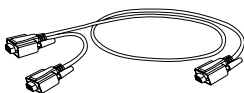

7. VGA-DB9 SYNC Splitter

2. PRODUCT DESCRIPTION

2.1 - Glasses EDGE™ 1.2

The VOLFONI Active 3D Glasses use fast-response liquid crystal lenses to create the best image quality. It is the brightest and most cost-saving 3D solution currently on the market.

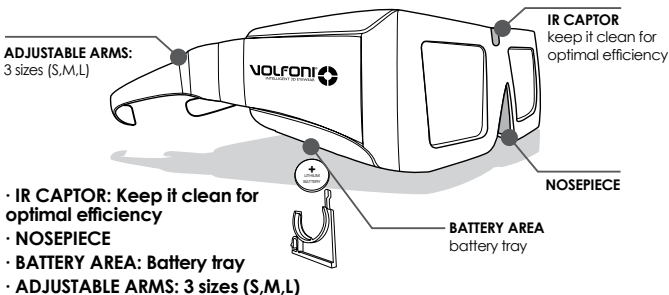

GLASSES USE AND SETUP

The 3D glasses do not need any setup to start. It is nevertheless necessary to check all settings and connections of the 3D digital cinema system before projection. When started, the lenses need 2 seconds to warm up and turn into working mode. In working mode the lenses appear clear. When the 3D projection is finished or turned into 2D, the lenses will remain clear for about 5 minutes. They will go directly into operation mode again when a new signal is received.

BATTERY REPLACEMENT

To open the battery encasement on the right arm of the glasses:

- Use your Volfoni battery tool.
- Put the glasses on a desk/table as it will be easier to hold.
- Find the small hole on the right arm of the glasses, where the arm connects with the battery encasement, 1 et 2.
- Put the battery tool inside and when you hear a "click", you can pop open the battery encasement, 3.

make sure you install the battery in the right position

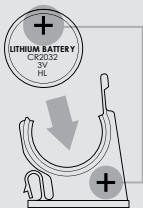

BATTERY TOOL to unlock the battery

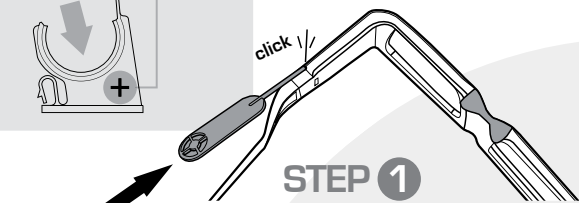
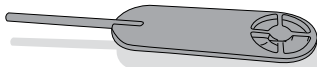

Insert the tool into the hole in the under right side of glasses until you hear the "click".

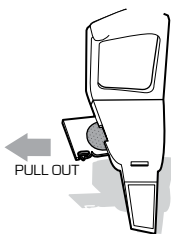

Pull towards you with your nail to remove the battery tray

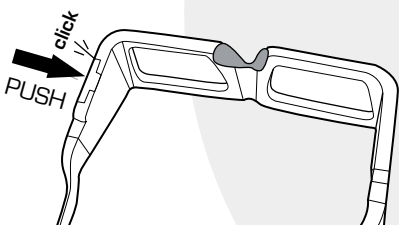

Reinsert the battery and push to hear the "click" to lock it.

Operating temperature: 0°C to 40°C
Storage temperature: -10°C to 60°C

Note: Please make sure that there is no obstacle in front of the IR captor during 3D projection.
Note: When the battery has less than three hours remaining, the lenses will flash once a second to indicate that you must change the battery. It is recommended to check the battery life before distributing to viewers.

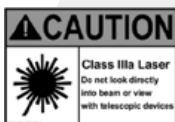

2.2 - Infra-red Emitter / Synchronizer

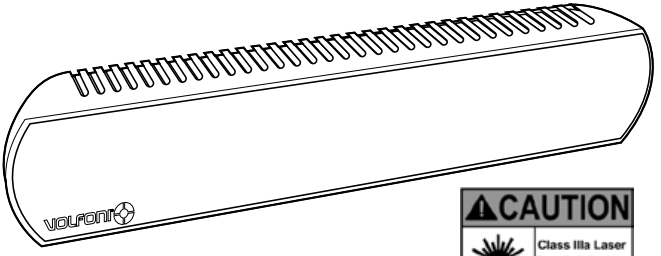

Long Range IR Emitter / Synchroniser

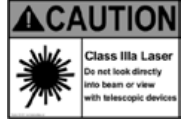

Model Name: VPES-02000

Long Range IR Emitter with built-in Synchronizer (VPES-02000) is a compact and very powerful technology for viewing 3D content in (bar, club, school, museum, events...) and small theater (up to 100 seats).

Thanks to its lightweight design, the ActivHub IR100 enhances heat dissipation (LED life protection). It is provided with a universal mounting head for security and is easy to install. It is also convenient to target the screen with the emitter laser pointer.

2.2.1 - Emitter/Synchronizer at a glance

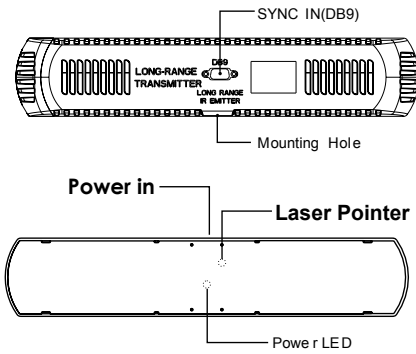

2.2.2 Basic specifications

IR Wavelength: 940nm

Max emitting range: 30 m (98.5 feet)

Power supply: 24VDC, 3A Power Adapter

Dimension: 361 x 70 x 44 mm (14.1 x 2.75 x 1.8 inches)

Weight: 500 grams (17,64 oz)

2.2.3 Direct infra-red spread of the emitter

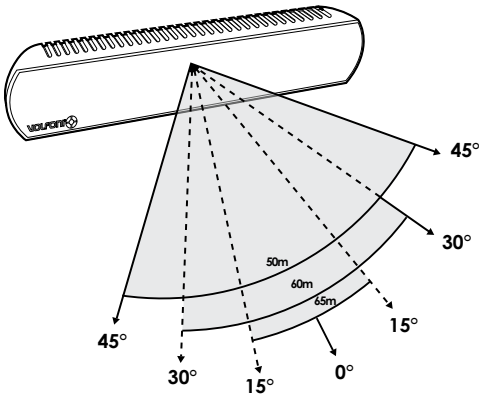

2.2.4 Room configuration

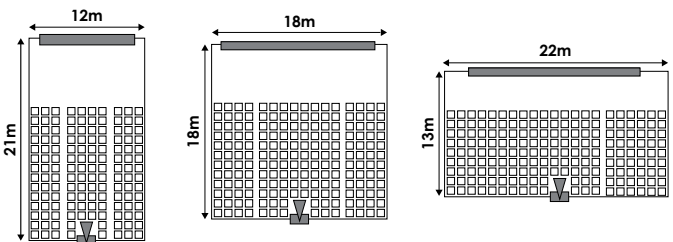

3. ACTIVHUB IR100 FASTENING

INSTALLATION



STEP 1

Use the wall base to mark each hole to drill with a pencil.

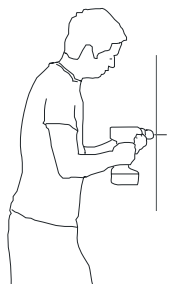
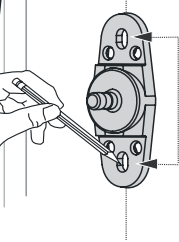

STEP 2

Drill the holes with the given bit (for wood surface only)

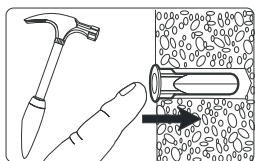

(For solid concrete and drywall only)

STEP 3

Insert wall anchors

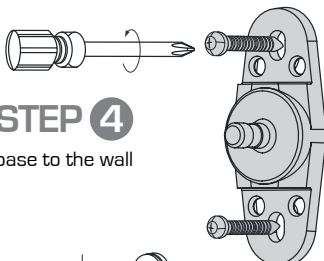

STEP 4

Tightly screw the base to the wall

STEP 5

Assemble the arm to the base and then screw the emitter on it

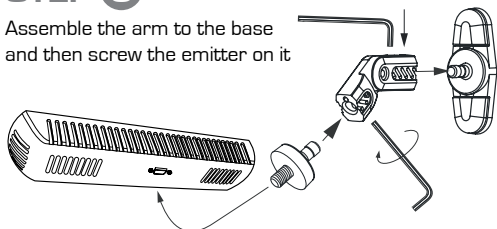

WALL FASTENER

Before installing the emitter in the front of the screen, make sure you have all the needed tools and the instruction manual. This wall fixing part is provided with all the screws and wall anchors you might need. Follow the instructions to fasten this kit.

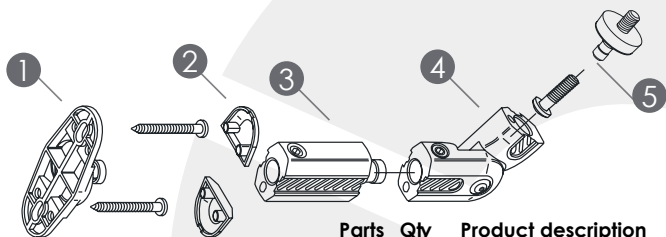

Parts	Qty	Product description
1	2	Mounting plate
2	2	Screw covers
3	1	Extension
4	1	Adjusting Knuckle
5	1	Emitter plate

WALL TYPES & HOLES SIZES

1/2" drywall

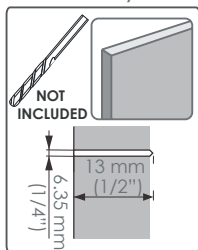

wood stud

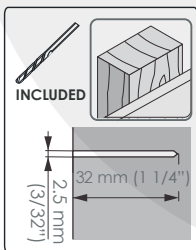

solid concrete

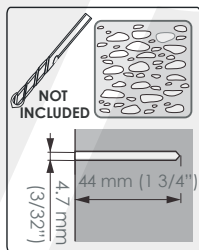

4. CONNECTION & SYNCHRONIZATION

4.1 - System connection

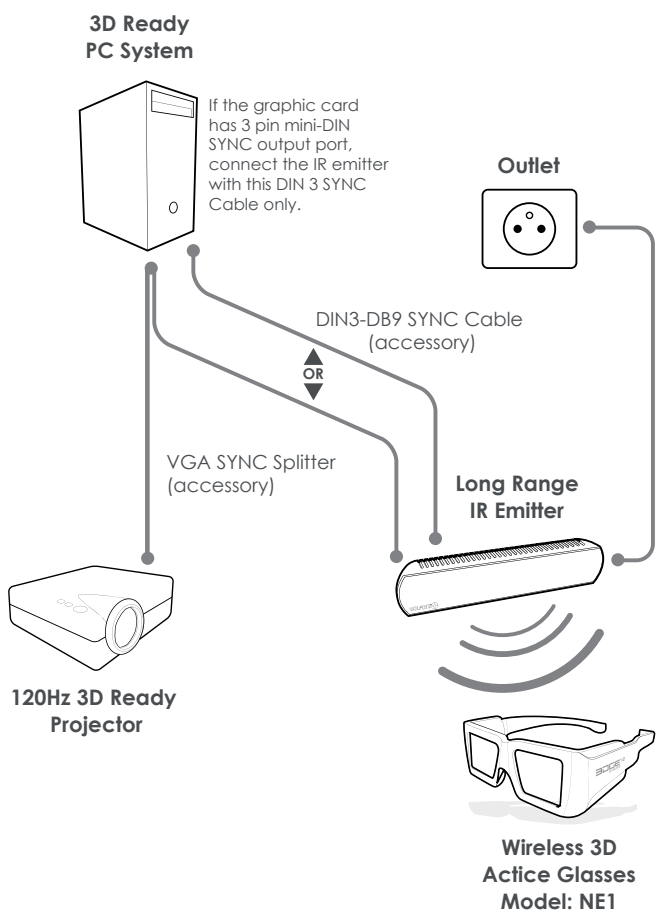
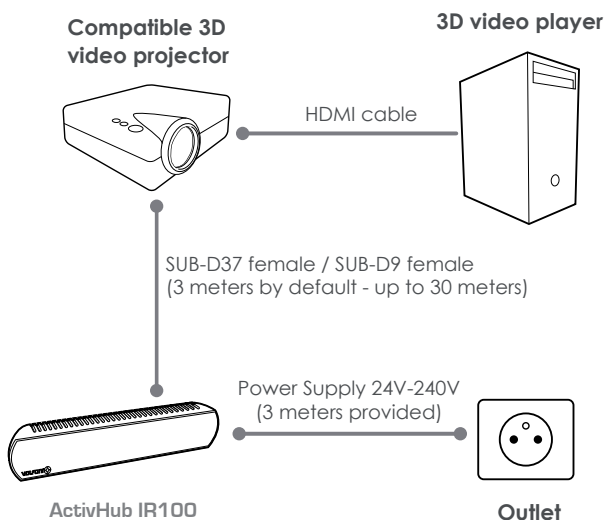

4.2 - Technical specifications

Please see below the connection diagram for the settings.
Please refer to the following technical board for the digital projector.
These parameters are for information, it could be adapted if necessary.

Fall time	0.2 ms
Rise time	1.8 ms
Contrast > 1:150 (no ghosting)	> 1:150 (no ghosting)
Transmission in the clear state	33%
Chromaticity <i>Standard parameters</i>	Color correction not mandatory

EDGE 1.0™ PCE SERIES

Double flash (4.2)	Darktime: 500
	Delay: -200
Triple flash (6.2)	Darktime: 800
	Delay: -200

EDGE 1.0™ STN SERIES

Double flash (4.2)	Darktime: 500
	Delay: -320
Triple flash (6.2)	Darktime: 800
	Delay: -320

Weight	58 grs (2 ounces)
Battery	Disposable
Autonomy	300 hrs

TECHNICAL SPECIFICATIONS

Warning: Depending on your equipment and the room configuration, you may have to adjust these parameters. We recommend to confide the set-up of 3D parameters and color adjustments directly to integrators.

For any trouble, please consult our website www.volfoni.com, or send an email to support@volfoni.com.

For any trouble, please consult our website www.volfoni.com, or send an email to support@volfoni.com.

5. Warranty

The ActivHub IR100 is warranted to the original purchaser for three to twelve months according to local legislation. Infra-red emitter/synchronizer and cables should be returned in original box along with original proof of purchase. Infra-red emitter/synchronizer that are broken or scratched are not covered.

Volfoni does not cover uninterrupted or error-free operation of the product under warranty.

6. Contacts

Distributed and made in France by VOLFONI SAS

29, rue Jean Jacques Rousseau
75001 Paris
France

Distributed in Germany by VOLFONI GmbH

Erzgießereistraße 38
80335 München
GERMANY

Distributed in US by VOLFONI Inc.

3450, Cahuenga Bd West.
Unit 504
Los Angeles, CA
90068 – USA

Distributed in Spain by VOLFONI Iberia, S.L.

4, Ronda Guglielmo Marconi
46980 Paterna (Valencia)
Spain

Distributed in UK by VOLFONI Ltd

90 Long Acre
Covent Garden
WC2E 9RZ London
United Kingdom

Technical support

support@volfon.com
www.volfoni.com

Commercial support

contact@volfon.com



www.volfoni.com